



## **Wall Mounted Water Fan Coil Operating and Installation Instructions**















Version 1.0

## Table of Contents

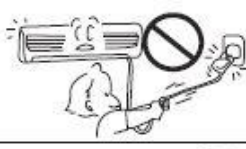
Safety Precautions.....	3
Part Names .....	4
Remote Control .....	5
Unit Operation.....	6
Use and Maintenance .....	9
Filter Cleaning.....	10
Safety Rules .....	11
Installation.....	12
Installation Chart .....	14
Wiring Chart .....	15

## Safety Precautions

Please read safety precautions before using the unit.

⚠ WARNING	
<p>Connect the unit to a dedicated circuit with no other loads.</p> 	<p>Do not apply an insecticide or <b>Flammable</b> spray.</p> 
<p>If a burning smell is noticed, stop the unit and disconnect the power.</p> 	<p>Do not operate for a long time in high humidity, eg. leaving a door or window open.</p> 
<p>Do not scratch or damage the power cord, etc.</p> 	<p>When the unit is not going to be used for a long time, disconnect the power supply.</p> 
<p>Do not pull the power cord.</p> 	<p>Always ground the unit. Do not connect a earth wire to a gas pipe, water pipe, etc.</p> 
<p>Disconnect the power before cleaning.</p> 	<p>Do not clean the unit with water.</p> 
<p>Do not operate switches with wet hands.</p> 	
<p>Do not put a pet or house plant in the airflow from air conditioner.</p> 	

## Part Names

### Indoor Unit

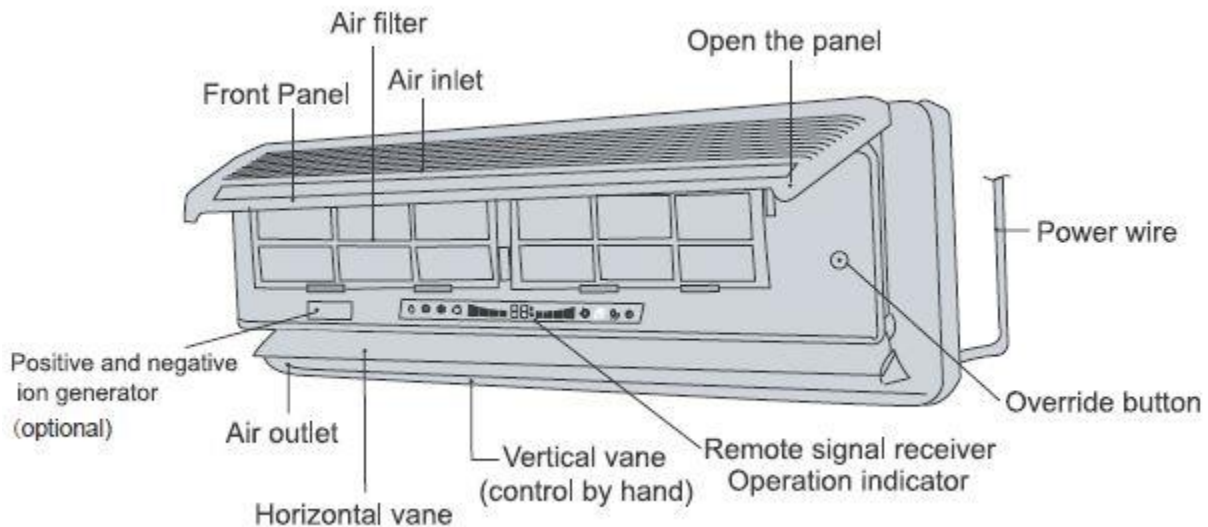

### Indoor Unit Display

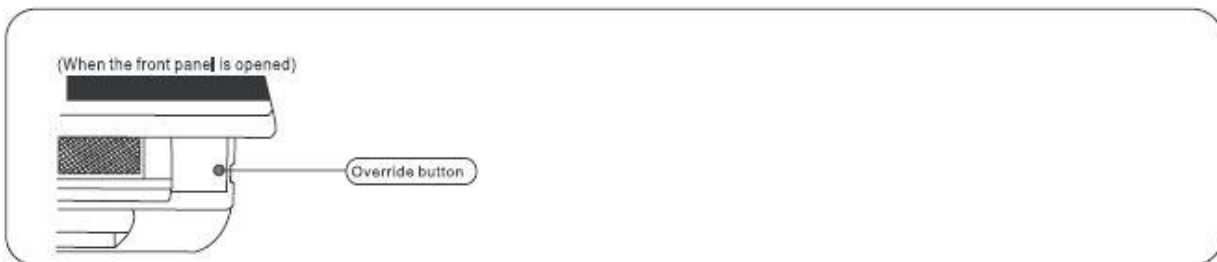
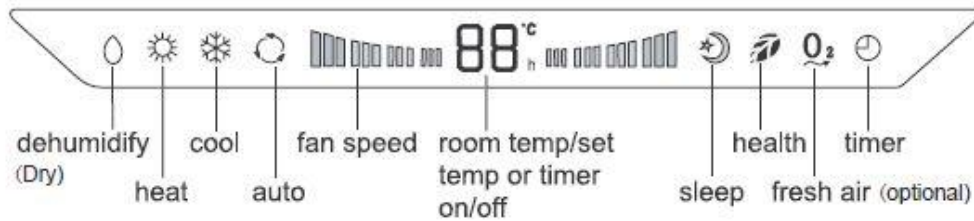

### Display Details

- The display section of the indoor unit has timer and operation signal lamps.
- When setting the "Timer On or Timer Off" the Timer Signal Lamp Lights.
- When the unit is turned on, the operation signal lamp "RUN" lights up.
- When the operation signal lamp "RUN" flashes, the unit has a malfunction.

## Remote Controller Functions

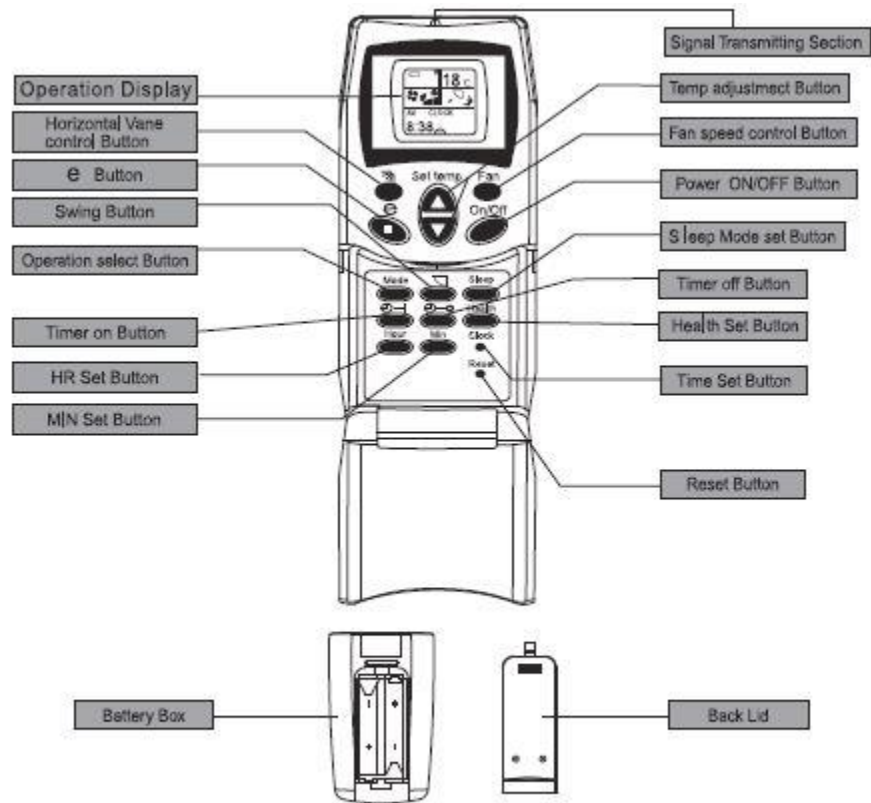

### Set Remote Controller Clock

### Operate automatically

1. Remove the back lid and insert two batteries.

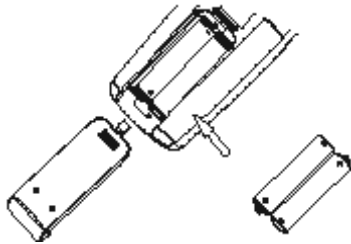

### WARNING

The batteries must be removed from the appliance before it can be scrapped and they are disposed of properly.

3. Clock set button

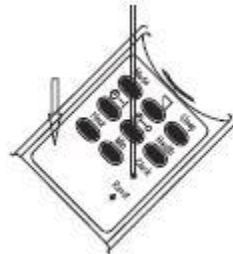

4. Press the HR and MIN buttons to set the current time, pressing the HR button adds 1 hour, pressing MIN adds 1 minute. Then press the set button.

2. Reset button

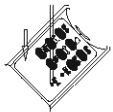

Press it by sharp object

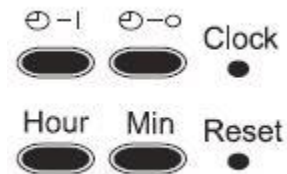

## Automatic Operation

According to the room temperature when the operation starts, the operation mode is automatically selected between COOL, DRY and HEAT. However, when the operation is started again within 2 hours after the operation is stopped, the same operation mode before it stopped is selected.

Room temperature when started	operation mode
About 70F or higher	COOL
About 68F -70F	DRY
About 68F or lower	HEAT FAN

## Starting Operation

1. The signal transmitting section of the controller should be pointing at the receiving section.
2. Press the ON/OFF button to start the air conditioner.
3. To select the auto mode, press the button to cycle through the modes. AUTO – COOL – DRY – HEAT.

## Stopping Operation

Press the ON/OFF button.

## If the room is too Hot or Cold



After about 15 minutes of run time, the temperature may need to be adjusted.

1. Press the "TOO COOL" button to raise the temperature, one press raises the temperature by 1F.
2. Press the "TOO WARM" button to lower the temperature, one press lowers the temperature by 1F.

## REMOTE CONTROLLER AND AUTO OPERATION

Selecting the "Cool, "DRY", "HEAT", "FAN": ON/OFF" Mode



1. Press the ON/OFF button to start machine.
2. Select the operation mode by pressing the MODE button. Each time this button is pressed, the operation mode is changed In sequence, from "AUTO - COOL – DRY - HEAT" (Example) To select the cool operation mode, press MODE button continuously until " cool" is displayed on the display screen

3. Press the  button to select the fan speed.
4. Press the  button to select air flow direction.
5. Press the  button to stop machine.

Note:

1. Once the operation mode has been selected, the same operation mode will start after the ON/OFF button is pressed on.





### Changing the set temperature

To lower the temperature, press the " " button, One press lowers the temperature by about 1°F. To raise the temperature, press the " " button, one press raises the temperature by about 1°F.

### DRY Operation

1. In "DRY" operation, the fan speed cannot be changed.
2. The room temperature is slightly lowered in this operation mode, the "DRY" function cannot be performed when room temperature is 55°F or lower.

### Air flow velocity adjustment

1. Press the  button to adjust the air flow velocity. Each time the button is pressed, the fan speed is changed as follows: AUTO→LOW→MEDIUM→ HIGH
2. To adjust the up/down swing, please press the  button. Each time the button is pressed, the swing will move one position.
3. When in "Cool" or "Dry" mode set the swing position to  , and "Heat" mode to  .









Note: To change the horizontal direction of the air flow, adjust the vertical vanes manually before starting the unit.

### Override Operation

Each time the switch is pressed, the unit alternates between the override COOL mode, HEAT mode and STOP mode.

## COOL, HEAT, DRY Fan Operation

### Setting the Timer on/off function

Press the timer on button  , the  appears in the display and begins to flash. It will last 1 min, to inform you that you can start to set the timer on  function. Press the timer on button again and the function will be cancelled. When the unit is on, press the timer off button, or press the timer on  button first to set the timer on. Press the timer off button and the  appears in the display and begins to flash for one minute. This is to inform you that you can start to set the timer off function. Press the timer off button again, the function will be cancelled. Press the  and  button to set the timer on and off. Each press of the  button will raise the time by 1 hour. Each press of the  button will raise the time by 10 minutes.

## Using the Timer on/off function together

Press the timer on button to set the timer on function first, and then press the timer off button to set the timer off function. At this time, the timers on/off functions are used together.

### NOTE:

1. Before setting the timer on/off function, please confirm whether the clock is set to the correct time.
2. If the current time is the time of the timer on/off, and the state of the machine is the same as the requirement of the time set, the operating mode will not change.
3. The remote controller has the capability of setting daily cycles of the timer on/off function. It also has the capability to set weekly cycles, Monday through Friday and turn the unit off Saturday and Sunday.
4. In the stop state, Press the "Temperature +" and "temperature –" at the same time, to set and cancel the weekly timer settings.

## Setting the "Sleep" mode





1. Turn the unit on.
2. Press the sleep button to enter sleep mode.

### Sleep Functions

1. The fan motor Indoor changes to the low speed.
2. In cool mode, each hour the temperature will rise by 1°F and will rise a maximum of 2°F throughout the night.
3. In heat operation, each hour the temperature will decrease by 1°F, and will decrease a maximum of 2°F throughout the night.
4. In dry operation, the room temperature does not change.

### Canceling the Sleep mode function

1. You can cancel the sleep mode function by selecting any of the following procedures.

Press the "Sleep" mode button , pressing the on/off button , pressing the Mode button  to change the mode, or press the  speed button to change the fan speed.

### "e" button Function:

Press the "e" button one time, the unit enters "AUTO" function mode controlling the fan speed and fan swing. Press the "ON/OFF" or "MODE" button to cancel the "e" Function.

### Night Light Function

The on/off button has a night light built in.



## Use and Maintenance

In order to increase the efficiency of the units operation, we recommend you use the unit as follows:

COOLING: For effective cooling, close all windows and pull down blinds. Heat from sunshine is reduced and cooling efficiency increases.

Paste a heat shield film on the window. Heat entering the room is reduced.

If the air conditioner will not be used for a long period of time, Perform FAN operation for 3 or 4 hours to dry the inside of the air conditioner. Remove the batteries from the remote controller, and disconnect the power plug if applicable.

Preparation and maintenance when the air conditioner is to be put back in service.

Clean the air filter and connect the power source. Be sure that the air inlet and outlet of the indoor unit are not blocked.

### General Maintenance

Turn off power supply before cleaning.

Clean the indoor unit using soft dry cloth. If the unit is very dirty, use a solution of detergent in lukewarm water first, then, clean it again using soft cloth dipped in clean water.

Clean the air filter regularly. (For details, refer to the section of cleaning the air filter). Do not operate the fan coil unit without the air filter installed in.

Do not use gasoline, benzene, polishing powder, detergent or hot water (106°F or more) to clean the fan coil unit.

### **BEFORE CONTACTING THE SERVICE DEPARTMENT**

The fan coil unit cannot be operated.

1. Check if the power plug is connected, the switch is turned on, and the breaker is not tripped.
2. Check if the power source is cut off.
3. If the fan coil unit is turned off, press the ON/OFF button again.
4. Check that the ON timer is not set.

### **Cannot cool or heat the room sufficiently**

1. Check that the temperature setting is correct. The set temperature should be lower than room temperature in COOL mode. While in HEAT mode, the set temperature should be higher than room temperature.
2. Close all doors, turn off electric heaters.
3. Clean air filters.

**Remote controller Display does not appear. The remote control won't change settings.**

1. The batteries are exhausted.
2. The polarity (+) (-) of the batteries is reversed.

### **Caution**

During an electrical storm, stop operation and pull out the power plug or turn off the switch. Otherwise the electrical parts may be damaged by lightning. In a weak radio wave area, when the fan coil unit is operated, noise may be generated in SW radio reception. The remote control signal may not be received in a room when an electronic type fluorescent lamp is used.

Even if the above items are checked, and the fan coil unit does not recover from the trouble, stop using it and contact the service dealer or the manufacturer reporting the product type and the failure details.

### **CLEANING OF THE AIR FILTER AND DEODORIZING FILTER**

Clean the air filter (about every 2 weeks).

1. Open the front panel to the position as shown below and remove the air filter. (The position of the front panel should not be opened to horizontal level, otherwise the front panel may drop down).

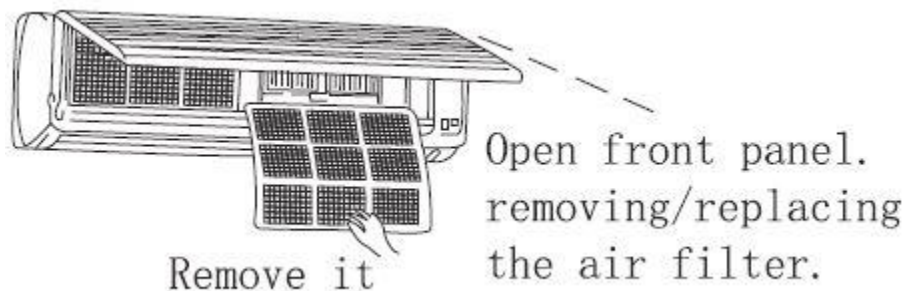

Remove the air filter.

2. Clean dirt from the air filter using a vacuum cleaner or by washing with water. If the dirt is thick, wash with a solution of detergent in lukewarm water (below 100°F).
3. Dry well in the shade after washing with water. Do not expose the air filter to direct sunlight or heat from fire when drying it.
4. Install the air filter and close the front panel.

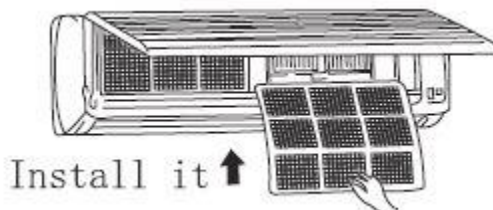

## **Safety Rules**

Before installing the unit, carefully read these 'safety rules and install it correctly. Since these cautionary items shown here are very important for safety, be sure to observe them.

- The customer should not install the unit by themselves. If this is done incorrectly, it may cause a fire, electric shock, injury by dropping of the unit, water leakage etc.
- Installation should be done according to the installation instructions. Drainage piping and refrigerant piping connection work refer to the installation descriptions.
- After installation, check that if there is any refrigerant leakage place/point.
- Do not connect using branched outlet or an extension cord and do not attach many loads to one electric outlet.
- Install the unit in the place which can support fairly weight.
- Apply grounding. Do not connect a grounding wire to a gas pipe, water pipe, lightning rod or ground wire of a telephone.
- Do not install the unit where flammable gas could leak.
- Install an GFCI leakage breaker depending on the place where the air conditioner is to be installed (humid place, etc.)

## **Operational Issues**

1. Room air smells funny.  
The fan coil unit sucks in an odor, adhering to a wall, carpet, furniture, cloth, etc. Determine the source of the odor and eliminate it.
2. Fan stops during the DRY operation.  
If water is condensing in the heat exchanger evaporates again, the humidity increases. To prevent this, the fan operation of the indoor unit should be increased until the room temperature has dropped sufficiently.
3. Water flowing sound is heard during operation.  
This is the sound of refrigerant flowing inside the fan coil unit.
4. Fog flows out during COOL operation.  
When the indoor warm air is cooled the room temperature and the humidity is high, fog is formed. When the room temperature and humidity is reduced, the fog will disappear.
5. A mechanical sound is heard from the indoor unit.  
This is the sound of the switch turning ON/OFF the fan or compressor.
6. The remote control signal cannot be received.  
When the direct sunlight or strong lamplight shines on the remote control receiving sensor of the indoor unit, the remote control signal may not be received. Block the direct sunlight or turn down the lamplight.

7. Airflow direction is changed during operation.  
When the fan coil unit is operated in the COOL or DRY mode, and if the operation continues with air blowing down for 1 hour, the direction is automatically set to a level that prevents condensed water from forming. In the heating operation, if the output air temperature is too low or when defrosting is done, the horizontal vane position is automatically set to horizontal.
8. Frost adheres to the vertical vanes.  
If the unit operates in high humidity for a long time, water may condense on the vertical vanes and drip.  
Even if the above items are checked, when the air-conditioner does not recover from the trouble, stop using it and consult the service dealer or the manufacturer telling the product type and the failure details.

## Installation

Selecting the indoor unit installation location

- Install in a location where the air inlet and outlet are not blocked.
- Install in a location where the outflow air will reach all of the rooms.
- Install on a sturdy wall to prevent damage from vibration.
- Avoid a location where the unit will be exposed to direct sunlight.
- Install in a location where condensate water will flow out of the unit.
- Stay 3 feet away from TVs or radios to prevent distortion.
- To prevent the effects of a florescent light from interfering with the remote control receiver, keep the unit as far away from the light as possible.
- Install in a location where the air filter can be removed easily.

## Mounting the installation plate

Selecting the structure part (studs, column, etc.) on the wall and mounting the installation plate horizontally.

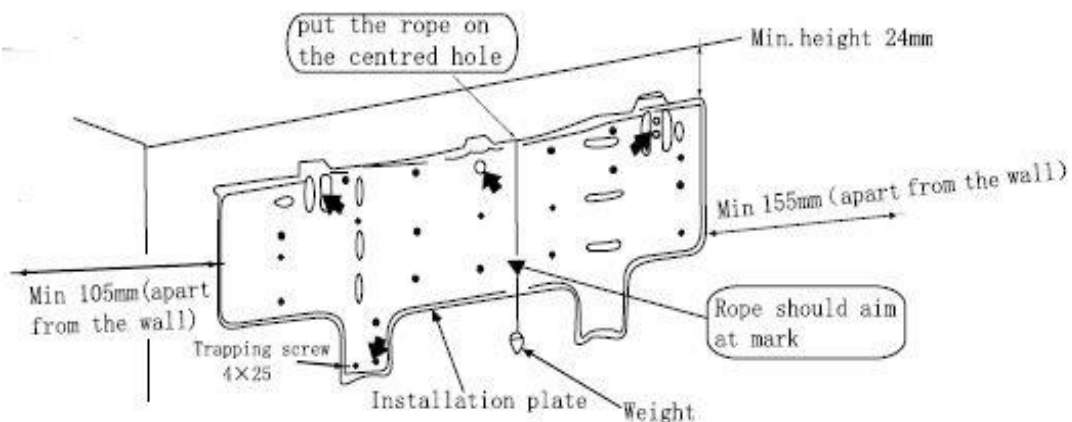

To prevent slight vibration from the installation plate, the holes marked with an arrow must be securely anchored.

## Drilling the hole in the wall

- Identify the position of the hole. The height should be lower than the low edge of the indoor unit.
- Drill a 4 inch hole and insert the wall socket.

## Refrigerant and drainage piping

- According to the requirement of the installation location, the refrigerant and drainage piping can be on the left, right, down, or rear.
- Wrap the piping with binding ribbons.
- Make sure to put the drainage piping below the refrigerant piping.

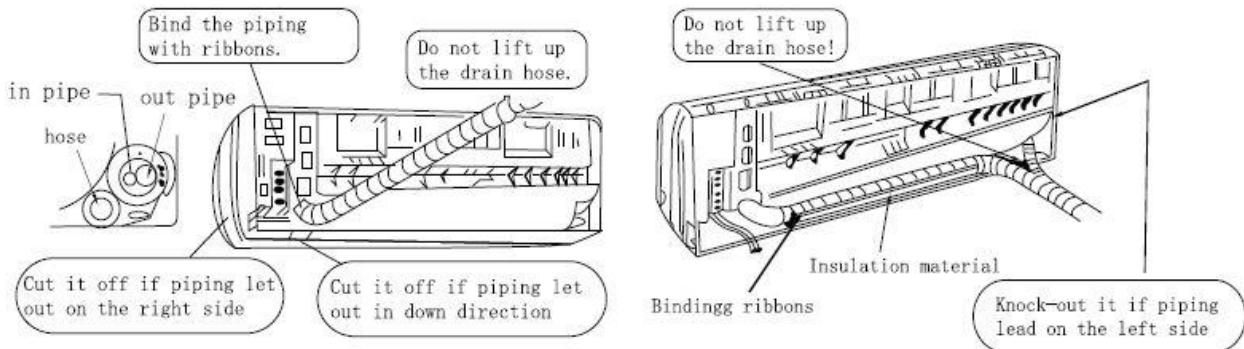

## Changing the direction of the drainage piping

- If the drainage piping is to be led from the left side, modification of the direction should be done. Otherwise the drain may be blocked causing water damage.

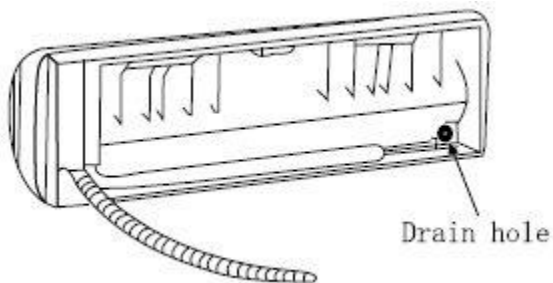

1. Remove the drain stopple.



2. Remove the drainage hose.

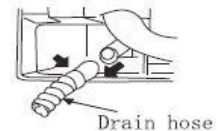

3. Insert the drain stopple into the drain hole on the left side of the indoor unit.

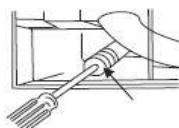

4. Insert the drain hose into the drain hole on the right side of the indoor unit.



5. Installing the indoor unit on the mounting plate.





# Wiring Diagram

