



CXRC1 Gen 2

Radiant Cooling Controller

An Add-On Dew Point Controller

Compatible with Most Radiant Heating Controllers

Allows safe condensation-free cooling with a radiant system.

Radiant Heating Hardwood Floor Controller

For Over-Temperature Protection

Compatible with Most Radiant Heating Controllers

Allows safe use of hardwood flooring with a radiant system.

Allows dual-temp hydronic heating.

Installation & Operation Manual

Read The Entire Manual Before Proceeding

Table of Contents

Operation Overview	3
Theory of Operation COOLING & Application Notes	4
Theory of Operation HEATING & Application Notes	5
Installation Overview	6
Fittings & Components Installation	7
Piping & Wiring Diagrams	10
Sensors Installation.....	11
Sensor Location	13
Controller Operation	14
Condensation Safety & Alarm Output	19
Testing & Troubleshooting	20
Determining Set Points / Calculators	22
Augmentation	26
Maximum Capacity Per CXRC	27
Manual Operation for Grey Actuator	28

CXRC1 Operation Overview

COOLING

Radiant cooling is the most efficient and comfortable method of cooling available for users in a dry or moderate climate and is highly beneficial even in humid climates.

However, if a radiant surface is operated below the dew point, unwanted condensation will be produced. A fast acting radiant cooling controller designed to prevent this, such as CXRC1, is required.

The CXRC1 is designed to be added to any existing radiant heating controller to enable the additional function of radiant cooling. The existing radiant controller will need to have thermostat(s) that are capable of calling for cooling. These can be added to nearly any radiant controller.

HEATING

For heating, no dew point sensors are used. Simply enter the maximum allowed temperature and the system will ensure that the radiant loop never exceeds that temperature.

To the right is a logical topology of the CXRC1 radiant cooling and radiant hardwood temperature controller.

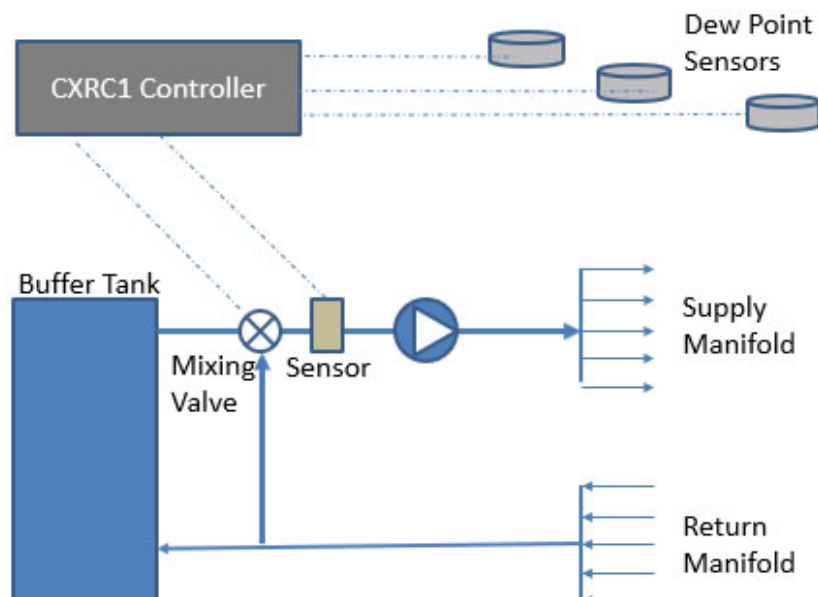

Theory of Operation - Cooling

The CXRC1 monitors the indoor dew point and compares it to the water temperature entering the supply manifold.

There is a cross-connect between the supply and return lines, and a motorized 3-way mixing valve that can mix water returning from the radiant system back into the supply, before entering the supply manifold, to quickly raise the temperature as needed to adjust the water temperature so that it will be above the dew point or above a pre-set delta to the dew point. This helps ensure that water entering the radiant system is at a temperature that will not produce condensation.

Application Notes:

The CXRC1 is not a radiant controller, it is an add-on to most any Brand or model standard radiant controller, to allow you to operate a radiant heating system in a cooling mode without condensation issues.

BEFORE ORDERING OR INSTALLING THE CXRC1, PLEASE CONSULT WITH CHILTRIX TECHNICAL DESIGN DEPT. TO VERIFY THAT YOUR RADIANT LOAD IS COMPATIBLE WITH RADIANT COOLING AND THAT YOU HAVE AN APPROVED DESIGN.

The radiant controller will need to have one or more thermostats that have the capability of cooling function. You may need to replace or add to your current thermostats.

2. This radiant cooling controller is designed to monitor indoor dew points and adjust the temperature of the water (or water/glycol) entering the radiant system such that the radiant surfaces do not drop below the dew point. This can prevent condensation (accidental dehumidification) which could cause water damage or inconvenience.

3. The system is ordered as follows: CXRC1-4 has 4x RJ45 Ethernet ports, can connect to one to four dew point sensors. CXRC1-8 has 8x RJ45 Ethernet ports, can connect to one to eight dew point sensors. DPX1 Dew Point Sensors are ordered separately.

4. All dew point sensors connect to the CXRC1 via CAT6 cable (supplied by installer). Up to 150 ft. cabling distance is allowed per sensor.

5. ASHRAE requires an indoor humidity $\leq 60\%$ RH to prevent EMC, corrosion, or mold. In some climates, you will need a dehumidifier to ensure this. A radiant cooling system cannot and will not dehumidify.

Theory of Operation - Heating

Radiant heating can be used successfully with all wood floors such as laminated flooring, engineered wood flooring, LVT, PVC, vinyl planks, linoleum, bamboo, and of course natural solid wood flooring. That means that any flooring can be used with radiant heating as long as the temperature is controlled so as to not exceed the maximum allowed by the particular material. For example, guidelines provided by The National Wood Flooring Association (NWFA) Radiant Heat Taskforce provide maximum recommended allowable operating temperature guidelines for wood floors. The guidelines were developed in response to recurring failures of hardwood floors placed over radiant floor heating systems. The maximum temperature allowed is specific to the manufacturer of the materials. The NWFA guidelines recommend the use of a temperature-limiting type of thermostat, in addition to the air temperature sensing portion of the typical thermostat and or the temperature controls of a boiler or heat pump. The CXRC controller can provide that “second layer” of thermal management to protect your floor and your flooring warranty.

Application Notes:

The CXRC1 is not a radiant controller, it is an add-on to most any Brand or model standard radiant controller, to allow you to operate a radiant heating system in a heating mode without exceeding a maximum allowed temperature.

BEFORE ORDERING OR INSTALLING THE CXRC1, PLEASE CONSULT WITH CHILTRIX TECHNICAL SUPPORT DEPT. TO VERIFY THAT YOUR RADIANT CONTROLLER IS COMPATIBLE. YOU WILL NEED TO PROVIDE THE MAKE AND MODEL, AND A PDF MANUAL OR A LINK TO THE MANUAL ONLINE FOR YOUR RADIANT CONTROLLER.

In heating mode the CXRC controller has an option for controlling how hot the water will be allowed to get on the outlet of the valve, much like controlling how cold the water is allowed to get in cooling mode. This is protection for certain floors that have a max temp of X degrees above which failure can occur. Most of the time you would set your main system to never exceed this temperature but in some instances, a fan coil or air handler may need a higher temp than the flooring materials can handle without damage occurring. This is where the CXRC can control the max temp that goes to the radiant loop effecting a dual-temperature system and a secondary layer of control.

The user has two set points in order to enable this setting.

“Max Heat Temp”: this is the maximum temp safely allowed for your radiant loop.

“Heat Mode Enabl”: this is the water temp in which the controller will start to look at outlet temp and determine if it needs to control the outlet temp.

1. READ THIS MANUAL IN IT'S ENTIRETY BEFORE PROCEEDING.
2. Verify the thermostats used with the existing radiant heating controller are capable of a cooling setting. If not, augment or replace the thermostats. Consult with the radiant cooling controller manual to see how to connect any new or additional thermostat or call Chiltrix technical support for assistance. Radiant cooling control can be configured to work with nearly all radiant controllers.
3. Install sensor well and PT100 sensor fitting.
4. Install the controller CXRC1.
5. Install supply-return cross connect and proportional mixing valve.
6. If used for cooling, install dew point sensors, run cabling, connect CAT6 cables to all dew point sensors to the controller according to this manual.
7. Connect all wiring according to this manual.
8. Determine and install optional customer-provided alarm output device if desired.
9. Configure controller according to the Chiltrix radiant calculators particularly using the "Surface temperature" tab and/or to not exceed any maximum allowed heating temperature.
10. Test system operation.

Installation of fittings



When installing any fittings, make sure that you use some type of sealant on all threads. Regular Teflon tape will work fine for sealant.

The included sensor fitting is 1 ¼ " FNPT, you can adapt to this as needed for your PEX or copper fittings. The fittings on the included 3 way valve are 1" FNPT.

Above is an image of the sensor fitting, a Tee-adapter from 1 ¼" to the ½". This size fitting is used to create a near-0 pressure drop sensor fitting for the PT100 sensor.

A properly installed PT100 sensor assembly



Three-way mixing valve



Your Siemens actuator may look like the grey one above rather than the white one shown in other pics. Both connect the same way.

Note, the arrow on the valve body must point towards the radiant manifold (away from the buffer tank). The orientation of the actuator does not matter.

Installation of Mixing Valve

When installing the 3 way valve please use Teflon tape on the fitting ports to prevent any water leakage. The 3 way valve must be installed with the white actuator on top as shown below. Secure the valve to a mounting board if it is directly connected to PEX tubing on all ends. The orientation of the actuator should be placed in the upper most position 0. (shown as 0 or 1 on the white version, not shown on the grey version) the internal position will self-calibrate once fully installed, connected, and turned on.

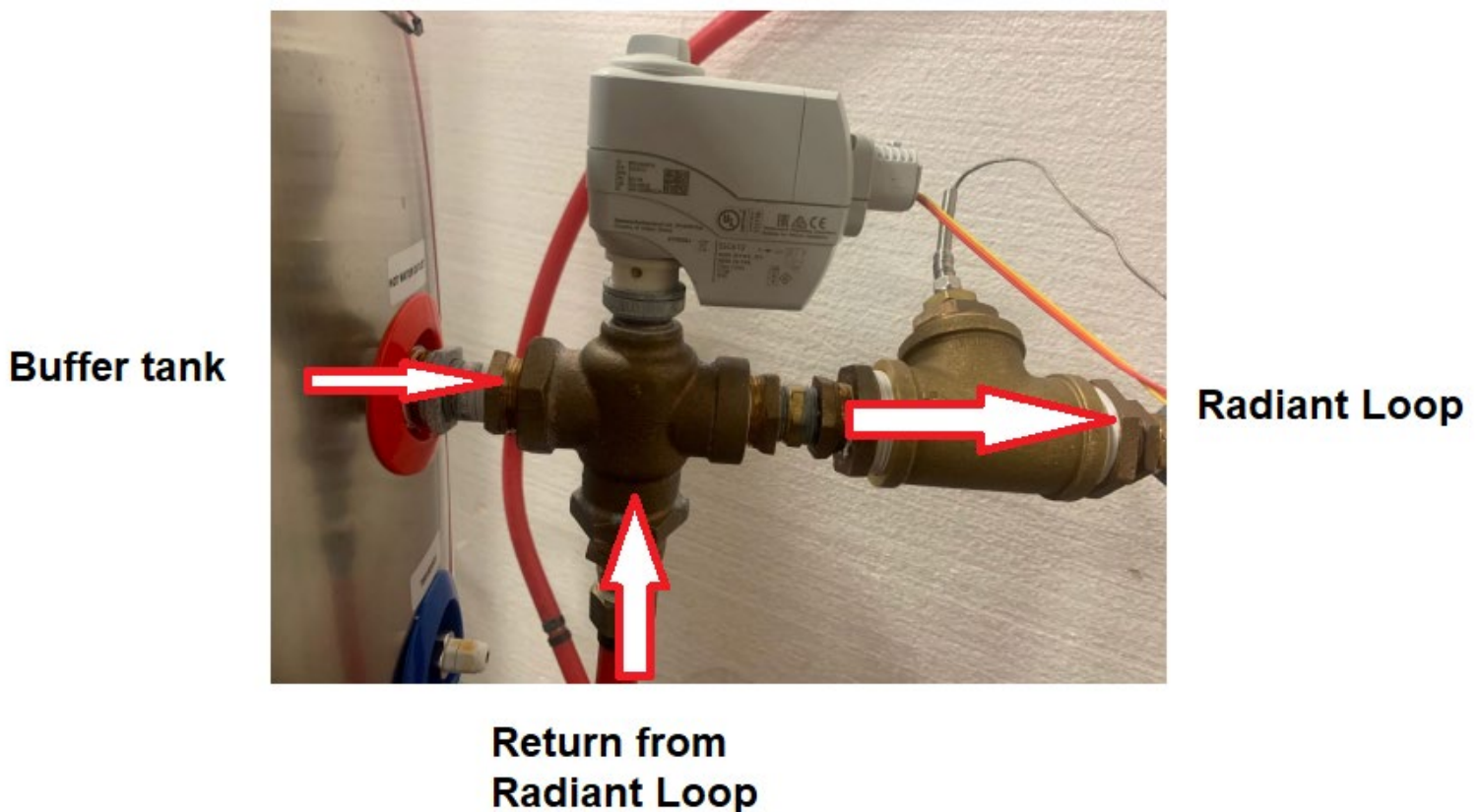

Above, valve supported by copper pipe on 2 sides

IMPORTANT NOTE

The mixing valve, cross connect piping, and PT100, MUST all be on the manifold supply line and MUST be “upstream” of the pump(s) as shown in the various diagrams of this manual.

Example Piping Diagram

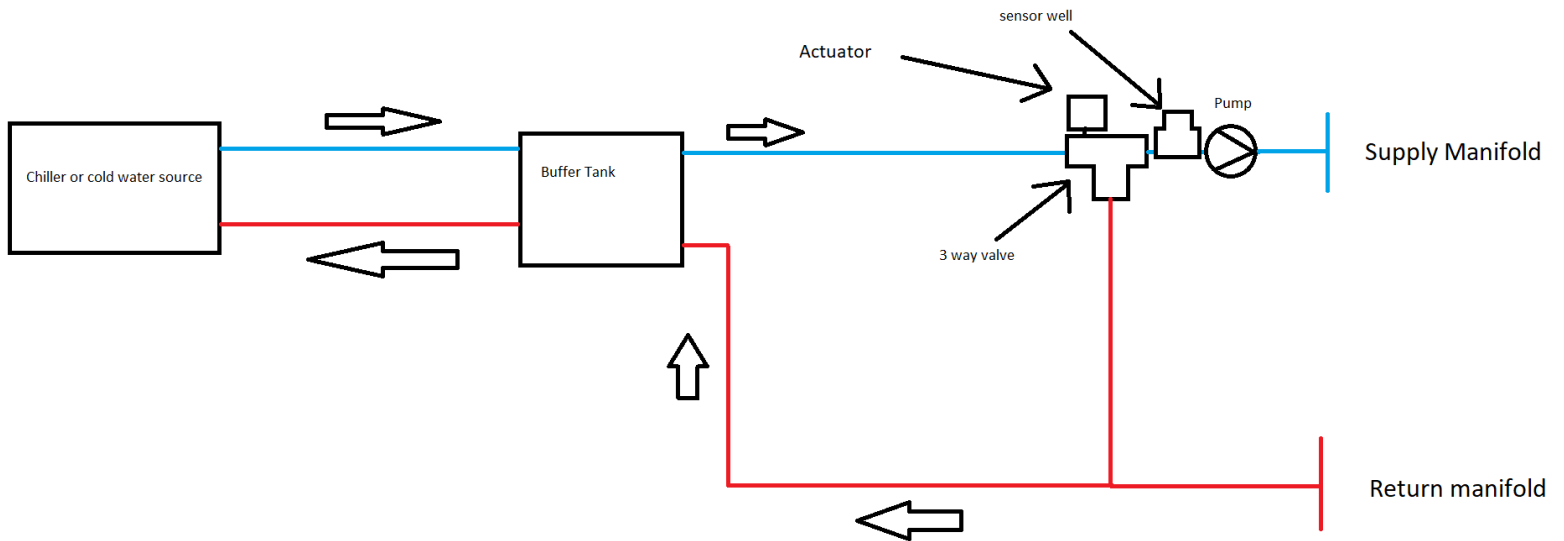

Wiring Diagram

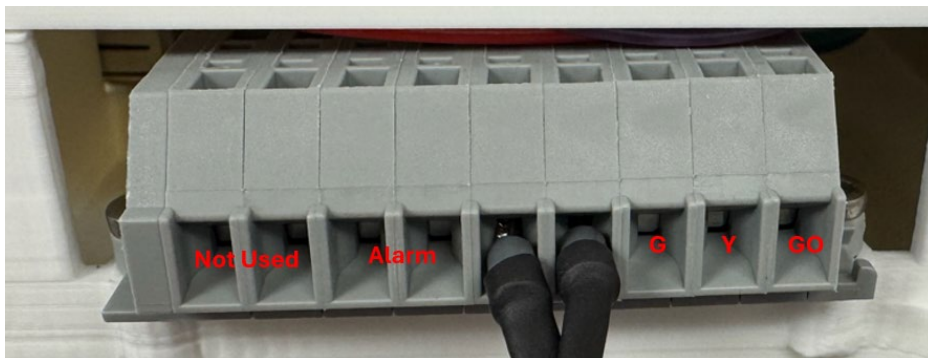
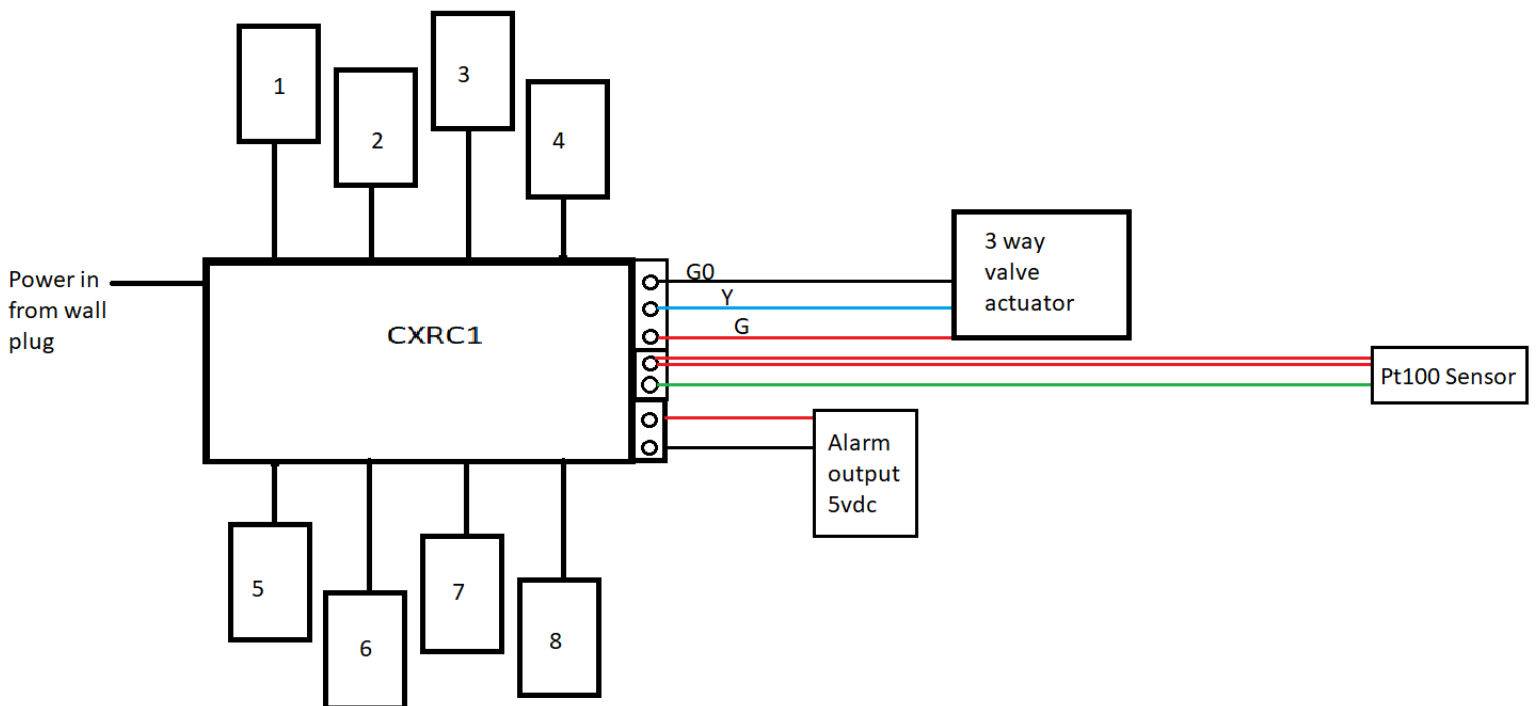

Mounting of the Controller and Dew Point Sensors for Use with Radiant Cooling

Mount the controller in a interior location near the mixing valve and PT100 temperature sensor fitting, and away from any exposure to water or dirt. Mounting tabs are located on the control box on each side. This location may be near the buffer tank, or near the manifolds.

NOTE: neither the controller or dew point sensors are water proof. It's also recommended to consider access to a wall outlet (110-120vac). The controller is powered by a 110-120 wall outlet plug.

Sensors

Mount each sensor in each area where you wish to monitor the dew point. The sensors have mounting tabs on each side just like the control box. The wire connector can go in two different ways. First method is to drill a hole in the wall and slide the connector through the back of the sensor box, it is an oval shaped hole. The short end of the housing "vents" can also be pushed out with your fingers to run the sensor wire through if you wanted to mount the sensor on the ceiling or along side a wall. Note these vents are designed to "breakaway" so they are relatively fragile. Be careful and don't break them by accident.

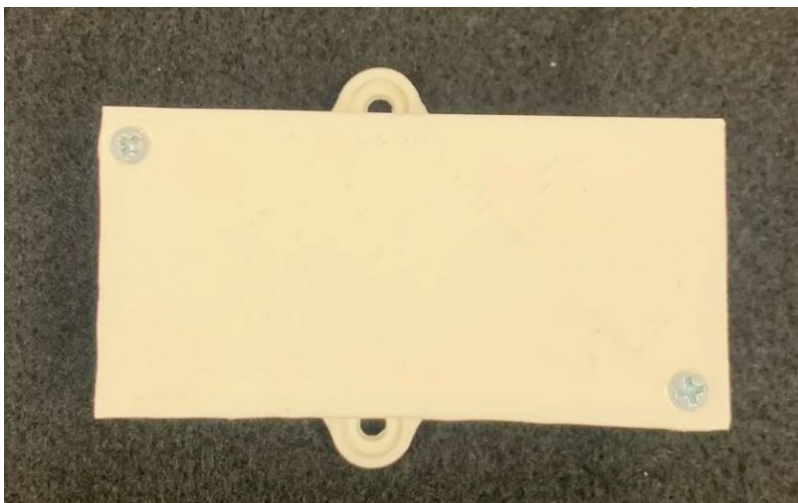
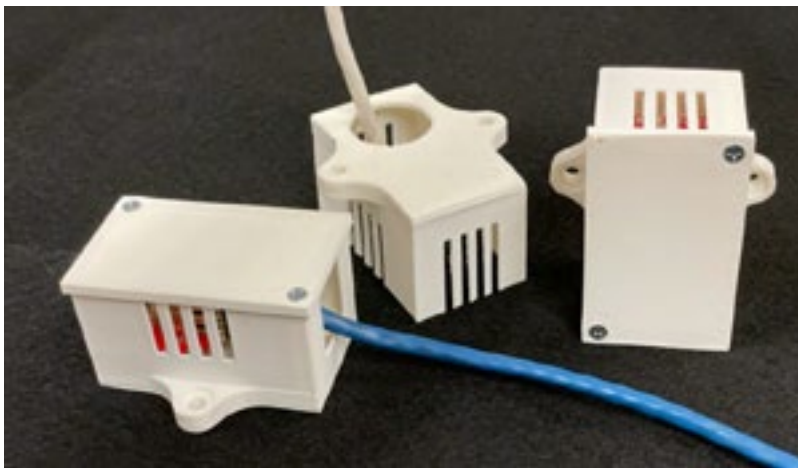

Dew Point Sensors

Dew Point Sensors – Rules: Where & How Many

1. Up to 1500 ft² of space that is in full fluid communication (air being a fluid) per DPX1. Meaning, any closed-off areas need an extra DPX1.
2. Minimum of one DPX1 per floor, subject to above.

Generally, bathrooms don't count as a closed-off area, since the door is usually open except for very short times. And during a shower or bathing any minor condensation on the floor should not be an issue, as minor wetness on floor probably happens at these times, with or without radiant cooling.



DEW POINT SENSOR CABLING

Sensor cabling is an installer-provided item. After determining the sensor locations you will need to measure the length you need and then order or make cable of the correct length with RJ45 connectors in order to connect the sensors to the controller. You can have up to 4/8 sensors connected to the controller according to which model was ordered, you can use as few as one sensor according to your needs.

USE CAT6 CABLE

Dew Point Sensors For radiant Cooling Proper Location

Location, Location, location – where to put the dew point sensors? So here we may hear a lot about classical physics and the ideal gas laws, in particular, Avogadro's Law and Fick's Laws of Diffusion. Without going deeper into this, these laws tell us that 1) humidity seeks equilibrium and does not need the actual movement of air in order to equalize across an area, and 2) that, as counterintuitive as it may seem, a volume of air is lighter when it has a higher humidity, and therefore rises. Don't worry about which law wins. In a cooler part of an enclosed space, RH will be higher because the air can hold less moisture, in a warmer area the air can hold more water, so the RH is lower. Neither have anything to do with the dew point unless the actual (absolute) humidity changes.

Don't worry about it or let the experts confuse you. Just locate the dew point sensors in the area served by the radiant cooling surface, and generally as near as practical to the surface that you are protecting from a dew point issue. We are only concerned about the dew point and not RH in this regard.

For most users, one or two dew point sensors, more or less central to the area, based on common sense, per floor, is all that's needed. If you use radiant from the ceiling you can put the sensors higher on the wall, for floor radiant it really does not matter. The sensor will cover all of the area up to around 1500 ft², on a single floor, that are in good fluid communication (air being a fluid). Closed-off areas need additional dew point sensors.

One note –if you have a persistent source of new absolute humidity, like a leaky pipe, fix it.

Another note – if you have a high cathedral type ceiling, this is a good location to pull in air for your dehumidifier,

CXRC1 Controller Operation For Radiant Cooling

The controller has firmware to read the sensors and control the valve position, the end user will need to set a temperature dew point offset. This temperature may be set by the user to automatically track the dew point, or may be set to operate at some delta above or below the dew point.

Note: In many cases the water temperature can be safely set below the dew point. See the section on temperature selection.

Ex: If you set the controller at “+2F” the controller will operate with a target temperature to the supply manifold as “dew point plus 2 degrees Fahrenheit”.

The controller will cycle between two different menus as shown below.

Valve Percentage: the valve percentage is the amount of water coming from the buffer tank out of the valve.

EX: 0% means no water from the buffer tank is being used. 100% means that the valve is acting as a straight through passage where no mixing is occurring.

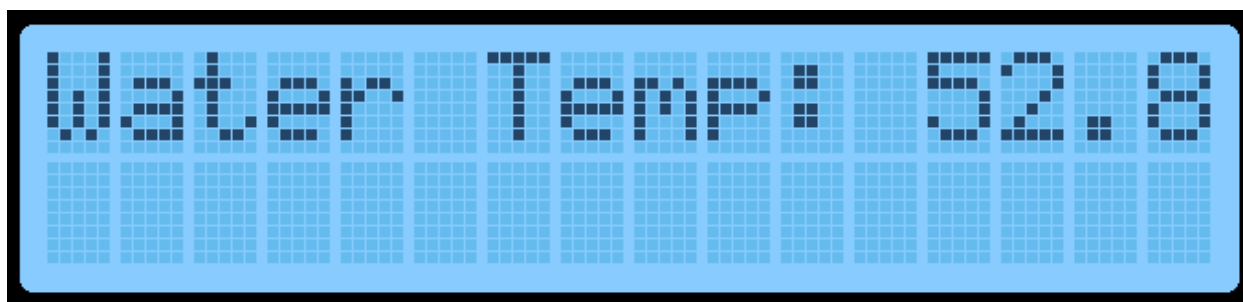
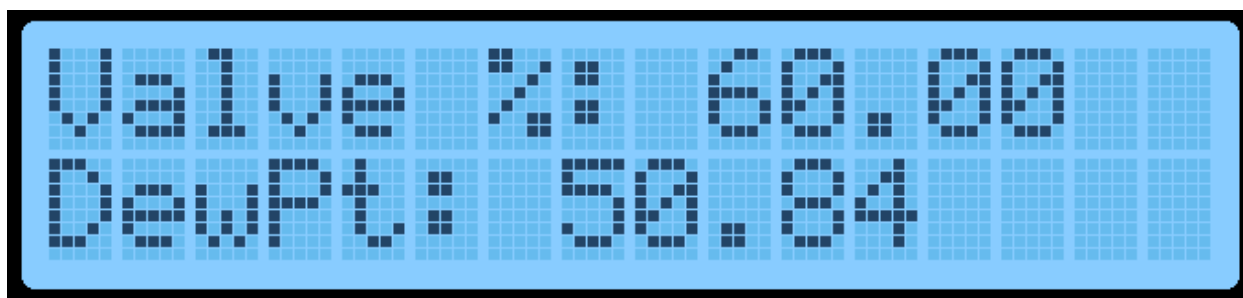

CXRC1 Controller Cooling Operation Cont'd

In order to change any settings on the controller you will need to hold down the menu button for about 5-10 seconds in order to enter into the main menu.

Once in the main menu, you can select “Dew Pt Offset”, this setting is the offset to which the controller will target the output water temp based on the highest dew point read (the highest reading of any individual sensor).

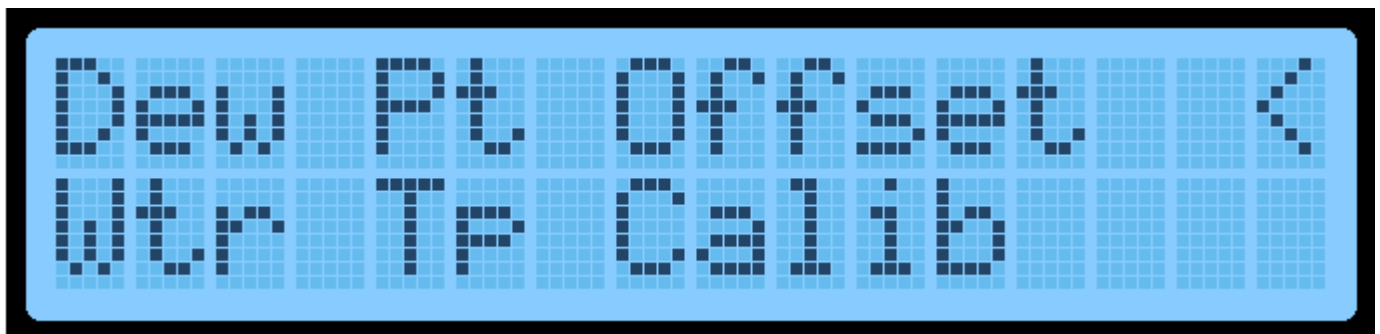

The dew point offset is a target in relationship to the dew point. Example: if the offset is +4F and the highest dew point read from the sensors is 54F then the controller will target an output temp of 58F. If the setting is -4F and the sensors are reporting a dew point of 54F then the target would be 50F.

The Dew Pt Offset is configurable to target an output water temp below the dew point in cases where you have a sealed system and a known R value between the surface of the water and the surface that is in contact with the rooms air temperature. See temperature selection section.

Wtr Tp Calib is used to slightly adjust the pt100 temp sensor if needed. If your sensor is reading high, set this negative. If your sensor is reading low, set this setting positive.

CXRC1 Controller Heating Operation

The CXRC1 can also control MAX temp for protecting water circuits. To change the max temp allowed for heating mode, select the menu below.

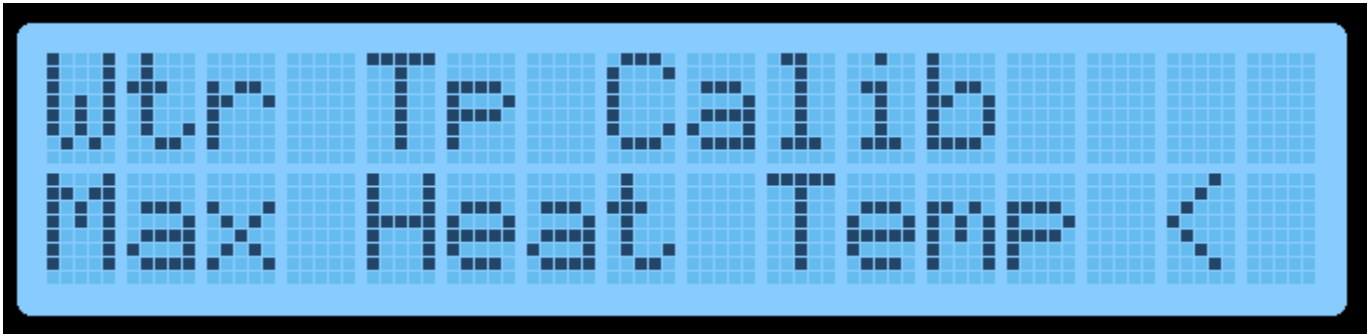

Select enter.

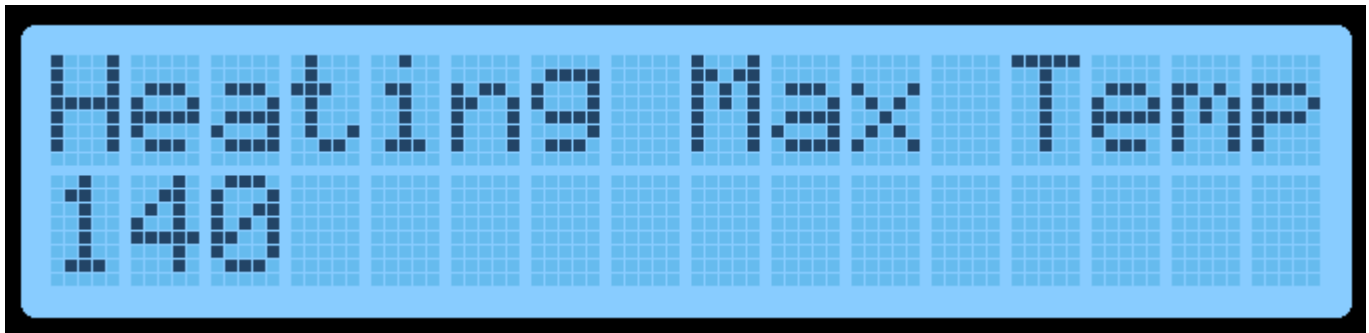

This is the max temp in F that the valve will allow out to the radiant loop. Enter the value required by your application and press ENTER to save your changes.

CXRC1 Controller Operation Cont'd

“Heat Mode Enabl” is used to set the water temp in F where the controller will start to look at the max outlet temp and keep it from going too high.

Select enter.

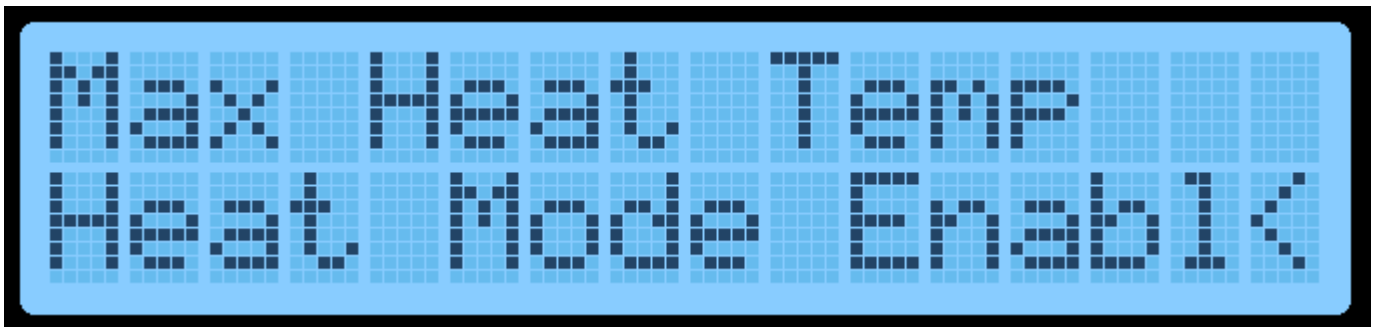

This is the temp at which the controller will automatically go into heat mode and determine if the outlet temp is too high, the default temp is set at 90F.

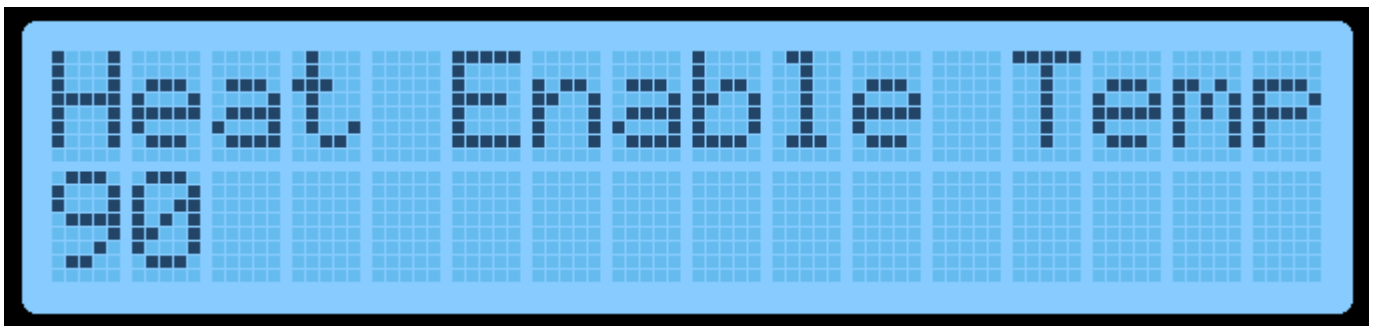

CXRC1 Controller Operation Cont'd

“Mode” is used to set the mode the controller will be used in for the duration of installation, this setting only needs to be set once. You do not have to change this setting every season.

Select enter.

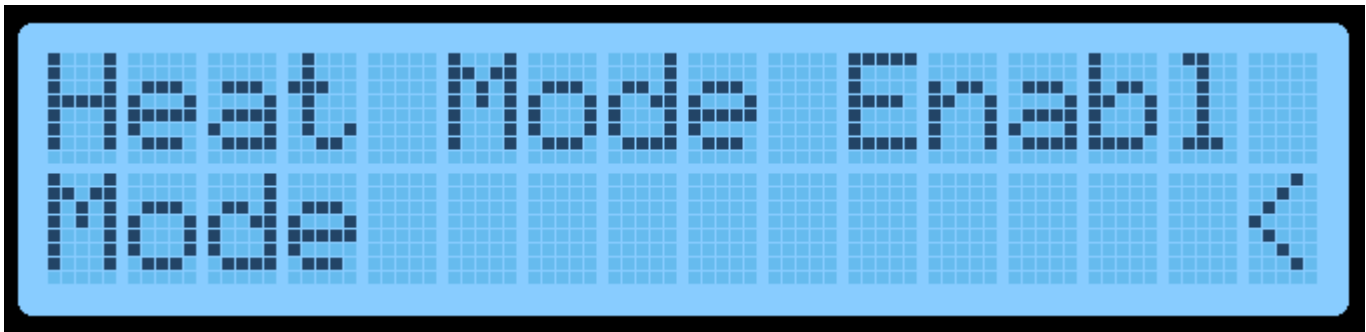

The default setting is Cooling mode only. If in cooling mode and the unit loses communication with the humidity sensor then the unit will fail safe to full recirculation mode.

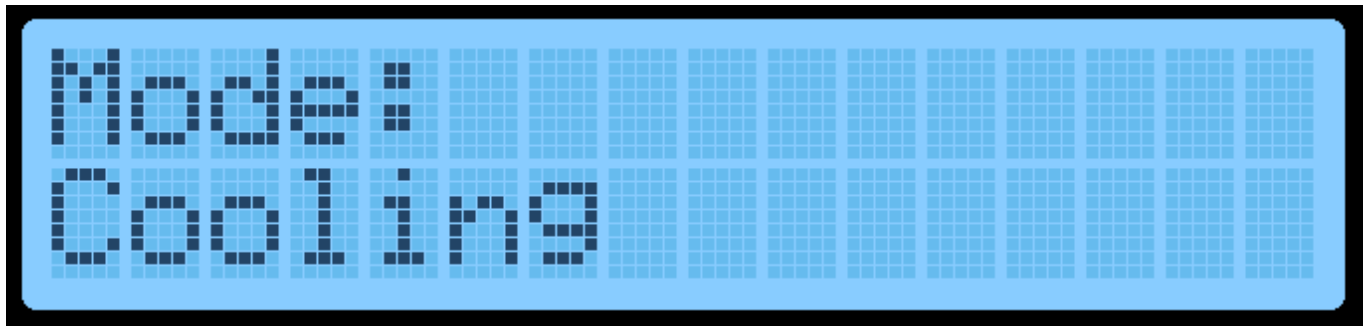

If the CXRC is in Heating or Heating/Cooling then the unit will not have a fail safe full recirculation if it loses communication with the humidity sensor as the sensors do not apply to heating.

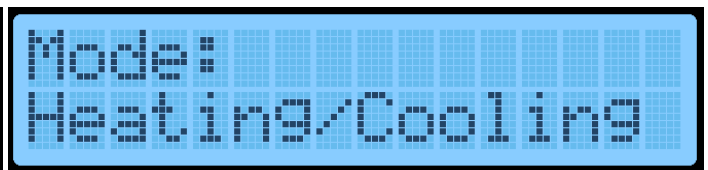
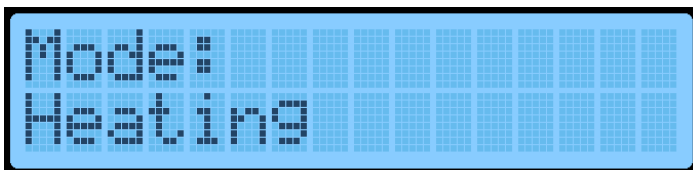

Condensation Safety Precautions:

It is recommended that the CXRC1 be powered from the same circuit as the pump(s) such that any power or circuit breaker problem that stops power to the CXRC also disables the circulator pump(s).

Alarm Output

The CXRC1 has a low-amp (.2a) 5v alarm output that can be used signal an error or loss of communication with dew point sensors. It is recommended that this be connected to a small solid state relay that can be set up to trigger a warning signal such as a bell or other alarm to let you know of a failed sensor.

If the mixing valve fails to receive communications from the controller but still has power, the mixing valve will move to full-recirculation as a safety precaution.

Testing & Troubleshooting

Testing:

Run the system and pay close attention to the radiant surface temperatures and dew point (see next page diagram) where unwanted condensation may occur and look for any condensation. There should be no wetness at all. Temperatures should agree with your projections within 1-2 degrees F, adjust as needed. Monitor this closely at various temperatures and conditions after initial startup, until you are sure your settings are sufficient.

Problem: Valve does not operate upon start up

Solution: Make sure your power wires are plugged in, if the controller LCD is not lit up then the valve does not have power. Upon start up the valve will start at full recirculation and then it will begin to modulate.

Problem: Valve is moving too much, too fast, too far, etc.

Solution: This is not exactly as it appears. This valve uses a gear reduction motor so the valve manual positioner that you can see may appear to move a very large amount, note that even an apparent full turn of the valve is only a small change to the actual amount of in mixing/non-mixing adjustment applied.

Problem: I am getting unexpected condensation

Solution: Check your calculations for error, or there may be an error in your R-value assumptions. If this cannot be corrected with adjustments on your own, please contact Chiltrix technical support (advanced support dept.).

How To Select The Proper Temperature Setting For Maximum Capacity

In any case where there is uninsulated or exposed piping at any point where condensation would be a problem, we suggest a setting of dew point +2F. Likewise, if the thermal sandwich is not vapor tight and properly insulated, use dew point +2. We suggest to properly insulate and use vapor tight taping or barrier to allow a lower offset to dew point and therefore higher capacity.

If all piping is insulated, and the back side of the “thermal sandwich” is also insulated well and vapor tight, a target below the dew point can often be used to gain more cooling capacity. The “thermal sandwich” refers to the radiant surface, and to what is behind it. An example below shows a typical thermal sandwich on a ceiling. The same logic is to be applied for floor or wall use.

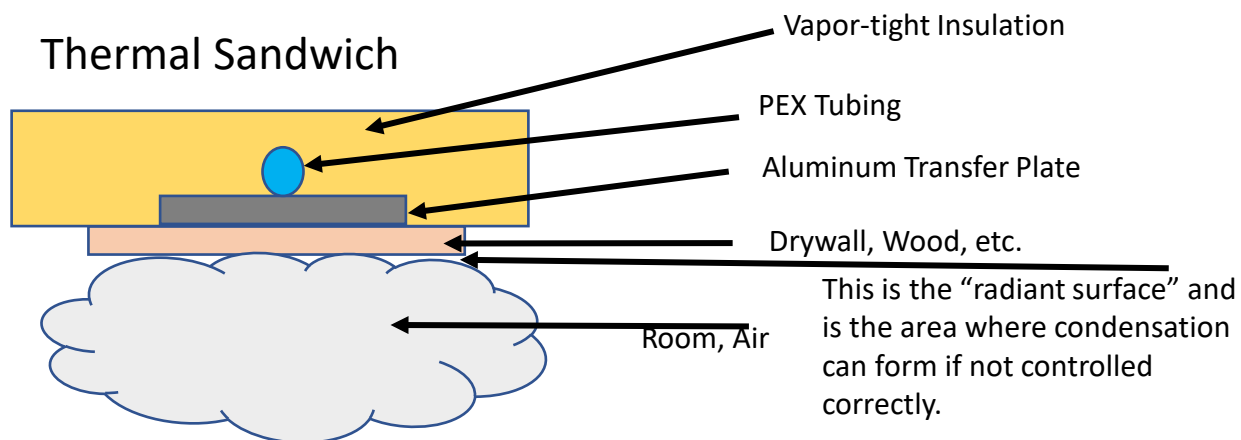

Above, “thermal sandwich” shown as ceiling radiant.
For floor radiant, just turn it upside down.

In the above example, assuming the piping and all insulation is vapor tight and has an R-value of at least as high as the sandwich section marked “drywall or wood”, the only surface where condensation risk is presented is the drywall or wood surface (the “radiant surface”).

The temperature target offset of the CXRC1 will be based on this surface and therefore the water temperature target can be lower than the dew point. You can use our surface temperature calculator to estimate a safe offset. See the calculators page. Any questions or uncertainty can be resolved by contacting Chiltrix Advanced Support (Engineering Department).

Radiant Cooling (and Heating) Calculators

Find The Best Temperature Offset For Maximum Capacity

Please refer to the calculators here:

<https://www.chiltrix.com/radiant-cooling/radiant-calculators/>

Please continue reading for an explanation of how to use the calculators.

About these calculators - in spite of the fact that most radiant systems are designed and configured based on rule-of-thumb or experience, there are laws of physics that can and should be used for proper design and configuration of any radiant system, for heating or cooling. Beyond just physics in fact, it is mostly related to quantum mechanics. To spare our partners and customers the burden of learning how to use Planck's constant, Kirchhoff's laws, Wien's law, the Stefan-Boltzmann Law, Newton's Law of Cooling, Fourier's law, and others, we have created some basic calculators.

On the calculator page you will see there are four tabs across the top as follows: Radiant, Surface Temp, Convert K to R, and Dew Point.

The Radiant Tab:

This calculator allows you to see the net radiant heating or cooling that can be obtained from a square meter or square foot of a radiant surface based on its temperature and the temperature of its local environment (i.e. the temperature of the "things" in the room to be conditioned – walls, furniture, floor, ceiling, people, etc. You will note there are two sections, in the top section you will input the following:

1. The emissivity of the radiant surface. This can be measured with an accurate laser thermometer with adjustable emissivity, used in combination of an accurate surface temperature sensor. Or more easily, you can look up the emissivity of most materials or coatings online, for example, here https://www.engineeringtoolbox.com/emissivity-coefficients-d_447.html or here https://www.transmetra.ch/images/transmetra_pdf/publikationen_literatur/pyrometrie-thermografie/emissivity_table.pdf

And there are many other resources online.

Radiant Cooling (and Heating) Calculators (cont'd)

Find The Best Temperature Offset For Maximum Capacity

2.

The next input of the Radiant calculator is the temperature. Note this is not the water temperature, rather it refers to the temperature of the radiant surface which we will get to in a moment.

3.

The next input is the area, please leave this as-is at 1 M² (the output will be converted for BTU per Ft.² automatically later on)

4.

In the next section, you can also input the average emissivity for a collection of normal things found in a room – wood, stone, plastic, fabrics, painted surfaces, etc. This can be left at the default value of .91 unless you have reason to change it.

5.

And in this section, you can input the average temperature of these “things” in the conditioned space. Generally for a radiant heating calculation you would use 65-68F. For cooling, we suggest 76-78F. Note that when using radiant, many users find that an indoor winter air temperature of around 64-65F is quite comfortable, due to the nature of radiant heating. Likewise with radiant cooling, users are often comfortable at 80F and report that it feels more like 75F.

6.

At the bottom, you will find the net output.

So how to define the radiant panel temperature? It will not be the same as the operating water temperature. Go to the Surface Temp tab.



Radiant Cooling (and Heating) Calculators (cont'd)

Find The Best Temperature Offset For Maximum Capacity

The Surface Temp Tab:

This is a handy way to estimate the surface temperature when you know the water temperature, and the R-value of what is between the water (PEX tube) and the radiant surface, and the air temperature of the room.

For “radiant temp” input a water temperature. You can play with some worst case scenarios, maybe from 45-65F. For air temp, you can also play with some worst case scenarios, maybe 70-90F.

For entering an R-value, this is where things get tricky. So in the thermal sandwich there may be multiple different types of materials. And many materials do not have a published R-value. But don't worry, there is a solution on the next page.

Once you have the R values (see next page for info on K to R conversion) along with the water temp and the air temp, you will be able to calculate the estimated surface temperature.

Radiant
Surface Temp
Convert K to R
DewPoint

Solving For Surface Temp				
Tc	radiant temp	55	PEX or heat exchanger F	
Ta	indoor air	75	Indoor room air F	
R value	R value	0.8	R-value seperating TC from Ta	
U value		1.25		
Th	Indoor surface temp	63.89	F	17.716049383
				C

Radiant Cooling (and Heating) Calculators (cont'd)

Find The Best Temperature Offset For Maximum Capacity

The Convert K to R Tab:

As mentioned, many materials will not have a published R-value that is easy to find. But nearly every material will have a published K value if you look for it. K value is essentially the inverse of an R value measured in $W/m^2/K$. Don't worry about what all of that means. Just find your K values online, here is a good example of where to find many material K values:

https://www.engineeringtoolbox.com/thermal-conductivity-d_429.html

Or here

https://www.researchgate.net/publication/336875733_DESIGNING_A_GUIDELINE_FOR_GREEN_ROOF_SYSTEM_IN_MALAYSIA

There are many online resources that list nearly every possible material, use a search engine if needed. Note, sometimes you may find K-values expressed as $mW/cm^2/K$. If so, convert the values to $W/m^2/K$ before using the calculator.

input	0.170000	K=(W/m ² *k)	
.	1.179477	U =BTU inch /(hr ft ² F)	
	0.847833	R per inch	
Input	0.80	inches	
	0.678266723	R total	

The Dew Point Calculator Tab

This one seems self-explanatory.

Dew Point Calculator	
INPUT TEMPERATURE °F	75 °F
INPUT RH %	60.00 %
OUTPUT DEW POINT F =	60.18 °F

Radiant Cooling Augmentation

If you are in a higher humidity climate, you may not be a good candidate for 100% radiant cooling. But even then, radiant cooling can be used along with a properly sized dehumidifier to provide up to 100% of your cooling, or, for augmentation.

Radiant cooling is excellent for augmentation of a normal air conditioning system to increase indoor air quality, allow for higher volumes of outside ventilation air, be more comfortable, save energy costs, or cool a stubborn area. In the case of augmentation, you may for example be able to do half of your cooling at an efficiency rate 3x higher than your conventional cooling system. That comes out to a 17% net energy savings.

Radiant Augmentation can allow expanded design and architectural flexibility. For example, if you will have a room with a lot of south facing glass, the floor itself can become a source of radiant heat that will seemingly defeat a conventional air conditioning system. The thermostat says the temperature is OK, but it still feels hot? That's one of the usually desirable effects of radiant heat, that in this case, when it interferes with cooling, it is not desirable. One option for this case is to use radiant floor cooling in that area, to zero-out the radiant heating effects of the floor that result from sun and window glass.

Note capacity limitations on next page.

Contact us with any questions.



Radiant Cooling CXRC Capacity Limits

What is the maximum cooling capacity in BTU's the CXRC do?

The maximum throughput of the valve limits both heating and cooling capacity but really, it is a matter of flow rate. In general, 15 GPM is a good upper limit, with 20 GPM considered as maximum. To translate this into BTUs, you would need to consider the design of the system, particularly the designed temperature drop. Since we always suggest a 10F T design for radiant heating or cooling we will give some examples of this below.

The valve has a CV of 10 so CV10 that means at 10 GPM the PD is 1 PSI (2.31 ft head loss). And when using glycol it can be further calculated from $Q = Cv[\sqrt{\Delta P/Sg}]$ so for example at 20 GPM PSI drop is 4 PSI (9.23 ft head loss). This is for pure water. Here is a simple to use calculator (and you can adjust Sg upward for glycol as needed) <https://www.milwaukeevalve.com/calculators/>

Heat transfer formula: $BTU = Sg * Sh * 8.34 * 60 * GPM * \Delta T$

We would suggest 20 GPM is the max you would ever want to use per CXRC valve. Lower flow like 15 GPM will have a more manageable pressure drop, be more quiet, and could be preferred.

With 20 GPM with a design 10F ΔT with pure water, that's around 100kbtu (heating or cooling) and that's what could be considered the max limit of BTU flow through the valve. Of course with a higher ΔT that could be increased by the percent of increase of the ΔT .

Pure water at 15 GPM would therefore be around 75,000 BTU.

And for 30% glycol, 15 GPM will deliver around 72,000 BTU

For a custom calculation, send us your details and we will calculate it for you.

You may consider using multiple CXRC units, we will be happy to consult with you on your design.

Radiant Cooling CXRC Manual Operation

If your Siemens actuator has the grey colored body, the below applies. For actuators with the white enclosure, use the positioner on top.

Manual operation

A 3-mm Allen wrench can be used to move the actuator to any position.

To move the actuator stem manually

1. Open the cover using a proper screwdriver.
2. Press and hold down button (a) illustrated below for at least three seconds.
 - The actuator ignores any control signal from the controller.
3. Adjust the position of the actuator stem by rotating Allen wrench (b) illustrated below clockwise or counter-clockwise.
 - The actuator stem moves down if you rotate clockwise; it moves up if you rotate counter-clockwise. The manually set position is retained.
4. To release the actuator from manual operation mode, press and hold down button (a) illustrated below again for at least three seconds.
 - The actuator runs a self-calibration automatically. Control signal sent from the controller takes effect.
5. Close the cover.

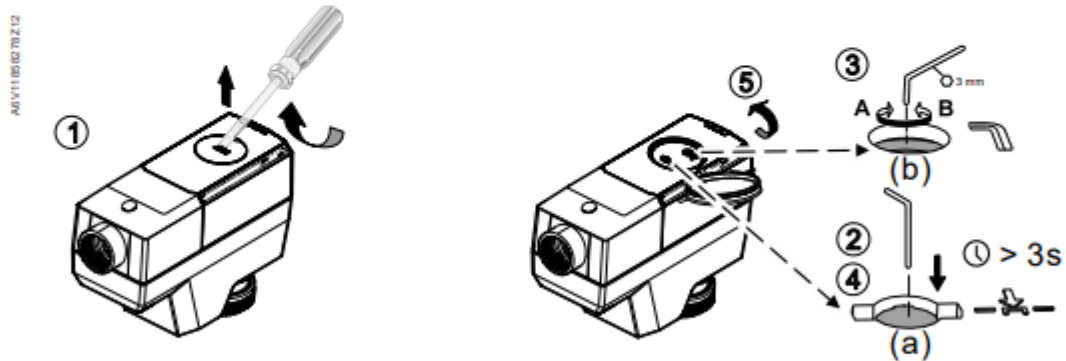

NOTICE



If operating voltage is applied to actuator, press button (a) before and after manually adjusting the position of the actuator stem. If no operating voltage and control signal are applied, manual operation can be done without pressing button (a).